

MARUYAMA

OPERATOR'S MANUAL
MANUEL DE L'UTILISATEUR
Manual del Operador

MS75E

PORTABLE POWER SPRAYER
PORTABLE PULVÉRISATEUR À DOS
PORTÁTIL PULVERIZADOR MOTORIZADO DE MOCHILA

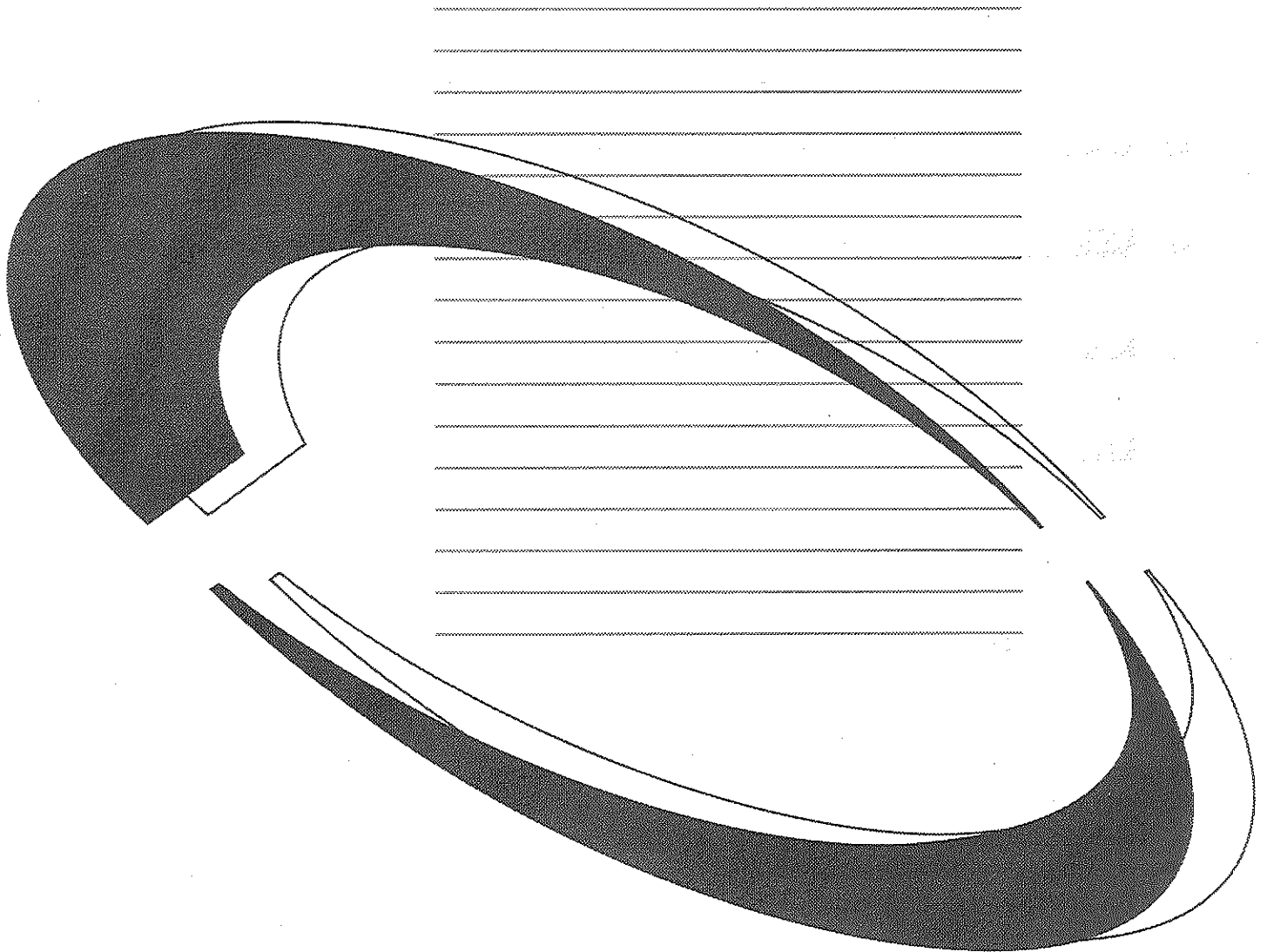

Premium Outdoor Power Equipment  **MARUYAMA** *Extraordinary.*

Completely read and understand this manual prior to using this product.

Lisez et assimilez la totalité de ce manuel avant d'utiliser cet appareil.

Lea y entienda este manual a fondo, antes de usar este aparato.

Preface

Thank you for purchasing MARUYAMA products. This operation manual explains the correct handling method, simple checks and maintenance of this product.

Please read this operation manual carefully, understand its contents, and use it to maintain the superior performance of this product.

Keep this manual after you read it and use it for the life of operation of this product. Note that discrepancies between the actual product and the content of this manual may be found as we are

continually improvements to provide better quality products to our customers.

Please send any inquiries about this product to your nearest sales outlet our sales office.

- Please keep this operation manual carefully.
- If you lose this operation manual, purchase a replacement at your nearest sales outlet or our sales office.
- Remodeling this product prevents safe and comfortable operation, and is very dangerous.

Warnings

In this manual, important handling cautions are indicated as follows:

 **DANGER** Death or serious injury is anticipated when not complying with the warning.

 **WARNING** Possibly death or serious injury is anticipated when not complying with the warning.

 **CAUTION** Possibly injury is anticipated when not complying with the warning

CAUTION Machine will possibly be damaged if not complying with the warning

When lending the machine to another party or having someone else operate it, provide training on the operating method in advance, and explain each at the warning labels with  (Safety caution mark).

In addition, provide the person with the operation manual and safe operation manual, and advise him to operate it only after reading these manuals carefully and mastering the operating method.

Remind the person about prohibited matters.

The same applies to your family.

However, children should be prevented from using this machine.

WHEN USING THE
MACHINE YOURSELF.

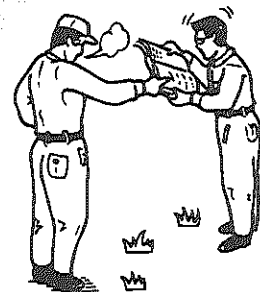



Limited Warranty Statement

All Maruyama commercial/ industrial products are warranted to the original purchaser to be free from defects in material and workmanship **from the date of purchase** for the time periods listed as follows:

Lifetime for inner drive shaft on trimmers and brushcutters and all ignition modules.

5 years for Commercial and Residential use.

1 year for Rental use.

All Maruyama engines and Kawasaki TK45/TK65 are covered exclusively for five years of industrial, commercial, institutional, and income producing use. These engines are warranted for one year of rental use.

This warranty will be in full effect provided the engine is operated for the initial 80 hour optimization period using Maruyama Premium 2-Cycle oil. After the optimization period the engine should always be run with either Maruyama Premium 2-Cycle oil or equivalent ISO-L-EGD & JASO FC 2-Cycle oil.

Any part of a Maruyama product found to be defective within the applicable warranty period shall, at Maruyama's option, be repaired or replaced without charge. Warranty consideration is obtained by delivering any Maruyama product believed to be defective to an Authorized Maruyama Servicing Dealer within the applicable warranty period.

The purchaser shall not be charged for diagnostic labor that leads to the determination that a warranted part is defective, if the diagnostic work is performed at a Maruyama Dealer.

Any warranted part which is not scheduled for replacement as required maintenance, or which is scheduled only for regular inspection to the effect of "repair or replace as necessary" shall be warranted for the warranty period. Any warranted part, which is scheduled for replacement as, required maintenance shall be warranted for the period of time up to the first scheduled replacement point for that part. Maruyama Mfg. Co., Inc. is liable for damages to other engine components caused by the failure of a warranted part still under warranty.

The purchaser is responsible for the performance of the required maintenance, as defined by Maruyama Mfg. Co., Inc. in the Owner's/Operator's Manual.

EMISSION-RELATED PARTS WARRANTY: In addition to the above warranty coverage, Maruyama Mfg. Co., Inc. will repair or replace, free of charge, for the original purchaser and each subsequent purchaser any emission-related part or parts found to be defective in material and workmanship for two (2) years from original retail delivery date **except catalytic converter. Catalytic converter is warranted one year from original retail delivery date. Emission-related parts are the carburetor assembly, the ignition coil assembly, the ignition rotor, the spark plug, the catalytic converter and the fuel tank.** Any replacement part that is equivalent in performance and durability may be used in non-warranty maintenance or repairs, and shall not reduce the warranty obligations of Maruyama Mfg. Co., Inc.

This warranty does not cover the following:

1. Maintenance items (excluding defects in materials and workmanship) including hoses, spark plugs, starter rope, air and fuel filters, clutch shoes, vibration isolators, throttle cables and all cutting attachments, etc.
2. Extra expenses including shipping and handling, travel, payment for lost time or pay and for any inconvenience and storage.
3. Alterations or modifications including aftermarket parts not authorized by Maruyama U.S., Inc.
4. Wear, accident, abuse, neglect, misuse, negligence, improper fuels, lubricants, fuel mixtures (when applicable), or failure to operate or maintain the product in accordance with instructions approved by Maruyama, repair or replacement as provided under this warranty is the exclusive remedy of the consumer.

Maruyama shall not be liable for any incidental or consequential damages for breach of any express or implied warranty on these products except to the extent prohibited by applicable law. Any implied warranty of merchantability or fitness for a particular purpose on these products is limited in duration to the warranty period as defined in the limited warranty statement. Maruyama reserves the rights to change or improve the design of the product without notice and does not assume obligation to update previously manufactured products.

This warranty provides you with specific legal rights, which may vary from state to state.

It is the Owner's and Dealer's responsibility to make sure the Warranty Registration Card is properly filled out and mailed to Maruyama U.S., Inc. Proof of purchase and registration will be required in order to obtain warranty service.

To locate an Authorized Maruyama Servicing Dealer nearest you, contact:

Maruyama U.S., Inc.
3570 Shelby Lane
Denton, TX 76207 U.S.A
940-383-7400
maruyama@maruyama-us.com
www.maruyama-us.com

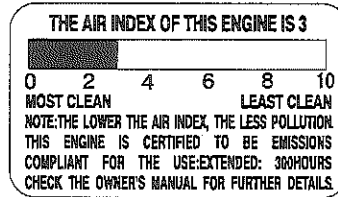
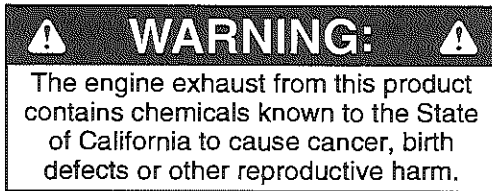

CALIFORNIA EMISSION CONTROL WARRANTY STATEMENT YOUR WARRANTY RIGHTS AND OBLIGATIONS

The California Air Resources Board (CARB), and Maruyama Manufacturing Company, Inc. are pleased to explain the emission control system warranty on your 2011 small off-road engine. In California, new small off-road engines must be designed, built and equipped to meet the State's stringent anti-smog standards. Maruyama Manufacturing Company, Inc. must warrant the emission control system on your small off-road engine for the period of time listed above provided there has been no abuse, neglect or improper maintenance of your small off-road engine.

Your emission control system may include parts such as the carburetor or fuel injection system, the ignition system, fuel tank and catalytic converter. Also included may be hoses, belts, and connectors and other emission related assemblies.

Where a warrantable condition exists, Maruyama Manufacturing Company, Inc. will repair your small off-road engine at no cost to you, including diagnosis, parts, and labor.

MANUFACTURER'S WARRANTY COVERAGE:

The 1995 and later small off-road engines are warranted for two years. If any emission-related part on your engine is defective, the part will be repaired or replaced by Maruyama Manufacturing Company, Inc.

OWNER'S WARRANTY RESPONSIBILITIES:

(a) As the small off-road engine owner, you are responsible for the performance of the required maintenance listed in your owner's manual.

Maruyama Manufacturing Company, Inc. recommends that you retain all receipts covering maintenance on your small off-road engine, but Maruyama Manufacturing Company, Inc. cannot deny warranty solely for the lack of receipts or for your failure to ensure the performance of all scheduled maintenance

(b) As the small off-road engine owner, you should be aware, however, that Maruyama Manufacturing Company may deny you warranty coverage if your small off-road engine or a part has failed due to abuse, neglect, improper maintenance or unapproved modifications.

(c) You are responsible for presenting your small off-road engine to a Maruyama Manufacturing Company, Inc. distribution center as soon as a problem exists. The warranty repairs should be completed in a reasonable amount of time, not to exceed 30 days.

If you have any questions regarding your warranty rights and responsibilities, you should contact Maruyama U.S., Inc. at 1-866-783-7400.

Emission System Parts

Exhaust Emission

Carburetor

Muffler

Catalytic Converter

Ignition Coil / Magneto

Spark Plug

Air Filter

EGR Valve (piston)

Fuel Filter

Evaporative Emission

Fuel Tank

**FEDERAL EMISSION CONTROL WARRANTY STATEMENT
YOUR WARRANTY RIGHTS AND OBLIGATIONS**

The U.S. Environmental Protection Agency (EPA) and Maruyama Manufacturing Company, Inc. are pleased to explain the emission control system warranty on your small off-road engine. New 1997 and later model year small off-road engines must be designed, built and equipped, at the time of sale, to meet the U.S. EPA regulations for small off-road engines. The equipment engine must be free from defects in materials and workmanship which cause it to fail to conform with U.S. EPA standards for the first two years of engine use from the date of sale to the ultimate purchaser. Maruyama Manufacturing Company, Inc. must warrant the emission control system on your small off-road engine for the period of time listed above provided there has been no abuse, neglect or improper maintenance of your small off-road engine.

Emission durability of 300 hours.

Your emission control system may include parts such as the carburetor or fuel injection system, the ignition system, and catalytic converter. Also included may be hoses, belts, and connectors and other emission related assemblies.

Where a warrantable condition exists, Maruyama Manufacturing Company, Inc. will repair your small off-road engine at no cost to you, including diagnosis (if the diagnostic work is performed at an authorized dealer), parts, and labor.

MANUFACTURER'S WARRANTY COVERAGE:

The 1997 and later model year small off-road engines are warranted for two years. If any emission-related part on your engine is defective, the part will be repaired or replaced by Maruyama Manufacturing Company, Inc. free of charge.

OWNER'S WARRANTY RESPONSIBILITIES:

(a) As the small off-road engine owner, you are responsible for the performance of the required maintenance listed in your owner's manual.

Maruyama Manufacturing Company, Inc. recommends that you retain all receipts covering maintenance on your small off-road engine, but Maruyama Manufacturing Company, Inc. cannot deny warranty solely for the lack of receipts or for your failure to ensure the performance of all scheduled maintenance. Any replacement part or service that is equivalent in performance and durability may be used in non-warranty maintenance or repairs, and shall not reduce the warranty obligations of the engine manufacturer.

(b) As the small off-road engine owner, you should be aware, however, that Maruyama Manufacturing Company may deny you warranty coverage if your small off-road engine or a part has failed due to abuse, neglect, improper maintenance or unapproved modifications.

(c) You are responsible for presenting your small off-road engine to a Maruyama Manufacturing Company, Inc. service center as soon as a problem exists. The warranty repairs should be completed in a reasonable amount of time, not to exceed 30 days.

If you have any questions regarding your warranty rights and responsibilities, you should contact Maruyama U.S., Inc. at 1-866-783-7400.

COVERAGE

Maruyama Manufacturing Company, Inc. warrants to the ultimate purchaser and each subsequent purchaser that your small off-road engine will be designed, built and equipped, at the time of sale, to meet all applicable regulations. Maruyama Manufacturing Company, Inc. also warrants to the initial purchaser and each subsequent purchaser that your small off-road engine is free from defects in materials and workmanship which cause the engine to fail to conform with applicable regulations for a period of two years.

The 1997 and later model years, EPA requires manufacturers to small off-road engines for two years. These warranty periods will begin on the date the small off-road engine is purchased by the initial purchaser. If any emission-related part on your engine is defective, the part will be replaced by Maruyama Manufacturing Company, Inc. at no cost to the owner.

Maruyama Manufacturing Company, Inc. shall remedy warranty defects at any authorized Maruyama Manufacturing Company, Inc. engine dealer or warranty station. Any authorized work done at an authorized dealer or warranty station shall be free of charge to the owner if such work determines that a warranted part is defective. Any manufacturer-approved or equivalent replacement part may be used for any warranty maintenance or repairs on emission-related parts, and must be provided free of charge to the owner if the part is still under warranty, Maruyama Manufacturing Company, Inc. is liable for damages to other engine components caused by the failure of a warranted part still under warranty.

EPA considers emission-related warranted parts to include all the parts listed below. These warranted parts are: the carburetor assembly, the ignition coil assembly, the ignition rotor, the spark plug, the catalytic converter, and the fuel tank.

MAINTENANCE REQUIREMENTS

The owner is responsible for the performance of the required maintenance as defined by the Maruyama Manufacturing Company, Inc. in the owner's manual.

LIMITATIONS

This Emission Control System Warranty shall not cover any of the following:

- (a) repair or replacement required because of misuse or neglect, lack of required maintenance, repairs improperly performed or replacements not conforming to Maruyama Manufacturing Company, Inc. specifications that adversely affect performance and/or durability, and alterations or modifications not recommended or approved in writing by Maruyama Manufacturing Company, Inc., and
- (b) replacement of parts and other services and adjustments necessary for required maintenance at and after the first scheduled replacement point.

Contents

Limited warranty statement	2
1.  In order to work safely	9
Cautions prior to work	9
Cautions when you useing this product	10
Cautions after the use	12
2. Name of each part and function	13
Warning label	14
3. Handling and operating method	15
Preparations for starting	15
Oil feeding and mixing	16
Start	17
Operation and shutting down	19
Throttle adjusting parameter	20
4. Cleaning, maintenance, and storage	21
Cleaning, maintenance and draining	21
Storage	22
Trouble-shooting and actions	23
5. Specification	24

1. In order to work safely

Cautions prior to work

The following persons shall not do spraying work.

- Person who cannot do normal spraying work due to fatigue, illness, effects of chemicals.
- Person who is under the influence of alcohol
- Person who is pregnant
- Person other than spray operator
- Children should be prevented from using this machine.

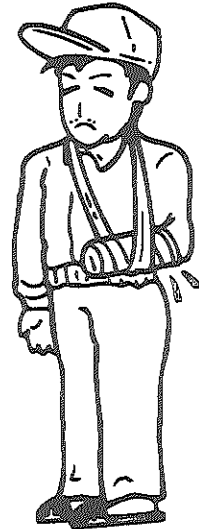
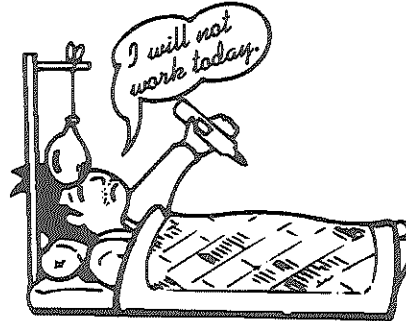
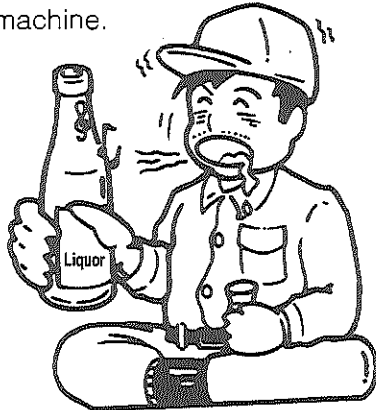

Appropriate clothes for the work shall be worn.

Spray operator who wears appropriate clothes.

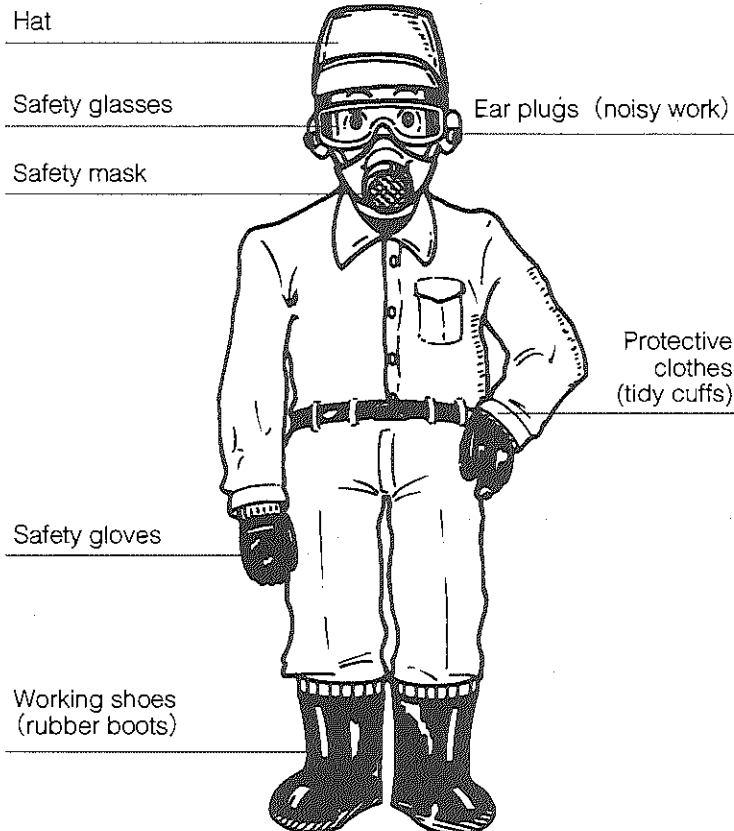

Check and maintain protective equipment to maintain their normal functions at all times, and use them correctly.

Cautions when using this product

This product can be used for the following agricultural work. Avoid use for purposes other than the following.

- 1) Spraying chemicals for blight or harmful insects on general farm crops
- 2) Spraying chemicals for blight or harmful insects on fruit trees
- 3) Spraying chemicals for blight or harmful insects on crops cultivated in greenhouse
- 4) Spraying chemicals for blight or harmful insects on flowers
- 5) Spraying disinfecting liquid or insecticide on farm house or chicken house
- 6) Spraying chemicals and water for blight or harmful on garden trees, bonsai, or lawns
- 7) Spraying disinfecting liquid and insecticide for urban sanitation
- 8) Spraying chemicals for blight or harmful insects on flower beds and in parks
- 9) Spraying weed killer to control weeds
- 10) Cleaning and spraying water for vegetables or root vegetables

When transporting by automobile, take action to prevent the machine from falling.



CAUTION

- Do not use this machine when there are people, children, or animals, near the site.
- Because the tank when completely filled with the chemical is very heavy, pay careful attention not to hurt your lower back when carrying it.
- Always adopt a safe working posture when carrying the tank. Do not work at elevated sites using stairs or ladders while carrying the tank.

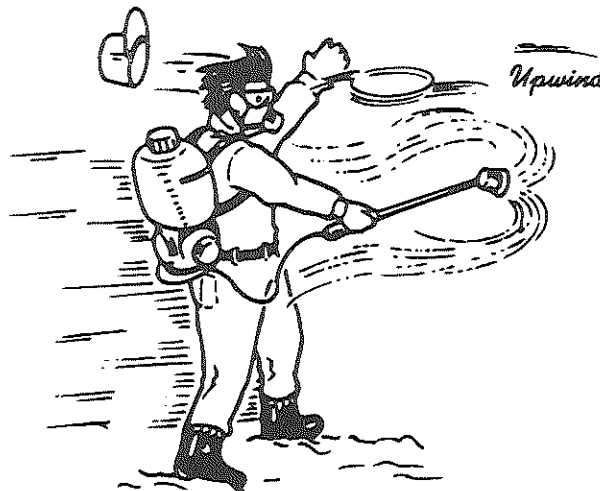

Chemicals

- Read labels of chemicals to be used carefully, and understand the method of use and cautions. When spraying quantity per tank (1000m²) or if the chemical is mistaken, agricultural chemicals can cause damage.
- Store chemicals in a safe place, and be careful not to break open their containers during transportation.
- Treat chemical containers to ensure safety.
- Pay attention to the handling of chemicals. If a chemical enters into eye or mouth, wash it off with water immediately.
- If you feel ill, see a doctor immediately.
- According to wind direction, change the spraying method to protect workers and houses. When spraying chemicals, work from upwind to downwind. Also give consideration to prevent chemicals from drifting or scattering on crops, enclosures, fish-breeding ponds, and houses nearby.
- When working in a greenhouse, pay attention to ventilation.
- Spray all of the chemicals and leave none in the tank.

Cautions when use this product

Confirmation of standard parts

After opening the package, confirm that all accessories are present.

If accessories are missing or damaged, inform the MARUYAMA outlet where you purchased the product.

Accessories

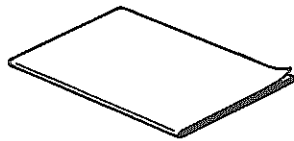

Operation manual



Warranty Registration Card

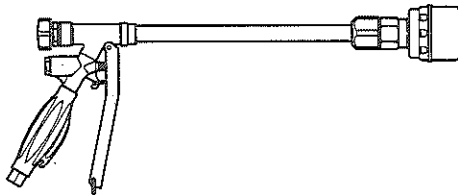

Nozzle

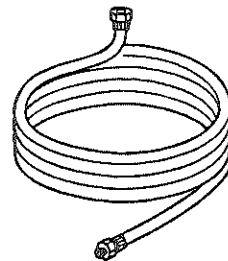

Discharge hose



Intake hose

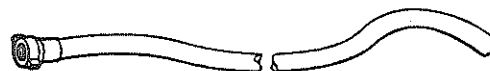

Bypass hose

Cautions when you use this product

Fuel

Fuel is Flammable, therefore observe the following to prevent fire.



DANGER

- Don't bring a open flame close to where fuel is supplied or the machine is maintained.
- When supplying fuel, make sure you stop the engine and wait for the engine to cool down. If fuel is spilled, wipe it off.
- When starting the engine, be more than three meters from the supply tank.
- Make sure you observe the mixing ratio of two-cycle engine oil to prevent the pollution of the environment and machine trouble.



CAUTION

- Don't use gasoline alone as fuel.

**When using general-purpose
two-cycle engine oil**

Gasoline	:	Two-cycle engine oil
50	:	1

Engine



CAUTION

- Temperature of engine is high during operation and immediately after stopping. You will get a burn if you touch the muffler, cylinder fins, etc.
- When starting the engine, confirm that the discharge valve is securely closed to prevent expulsion caused by a sudden spray.



WARNING

- Don't touch the spark plug during engine operation. You might get shocked.
- Don't operate inside a room. You might suffer by carbon monoxide poisoning.
- Don't breathe in the exhaust gas from the engine.

Pump

- Chemicals are sprayed from the nozzle at a high pressure. Don't spray them toward any people or animals.

Checks prior to work



CAUTION

- Check for loose screws in each portion.
- Loose screws cause accidents.
- Adjust length of carrying strap to fit you physique.

Cautions after the use

- When preparing chemicals, prepare the necessary amount only in accordance with the established spraying plan. If excess chemicals are left over, dispose of them as recommended on the chemical label.
- Remove all chemicals left in the tank and return them to their original container. Store it out of reach of children. Wipe off any chemicals on the machine. They might cause rust or other problems.
- To prevent fire, remove all fuel.

2. Name of each part and function

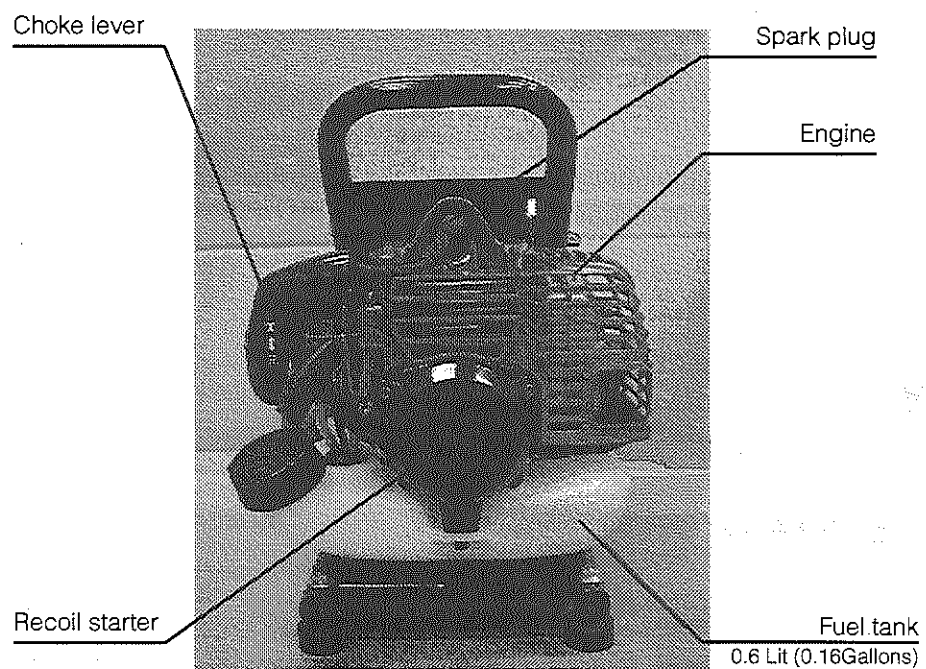
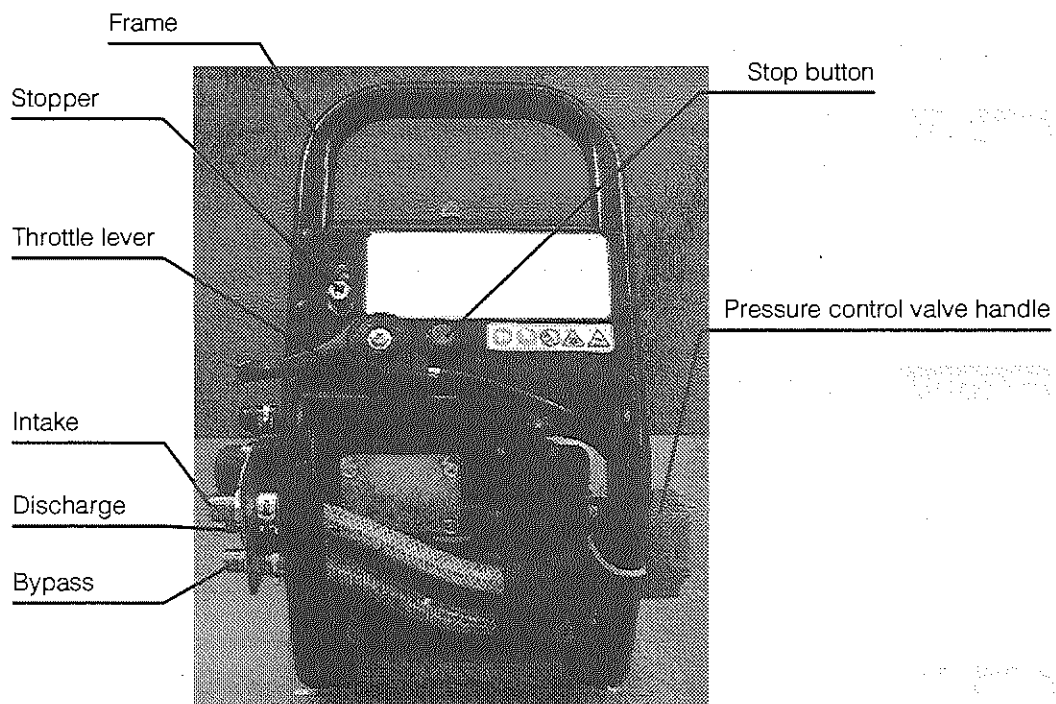

Warning label

- Always remove dirt or mud to make the indications legible.
- The following alarm labels are attached.

Alarm label

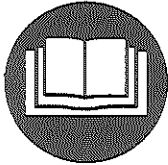

Read operation manual thoroughly.

Make sure you read the operation manual thoroughly prior to use.



Wear a protector.

Wear protectors such as hat, safety glasses, ear plugs during work.



Prohibition of fire

Don't put a open flame close to a place where supplying fuel or doing maintenance.



Cautions for exhaust gas

Take care not to breathe in exhaust gas from the engine.



Cautions for high temperatures

Muffler of engine, fin of cylinder, etc. are at high temperatures. Don't touch them.

3. Handling and operating method

Preparations for starting

- 1) Check that screws of equipment are not loose.
- 2) Connect hoses to pump as shown below. Connect discharge hose first, then bypass hose, and then intake hose. Then connect discharge hose to applicator (spray gun, spray wand, etc.).

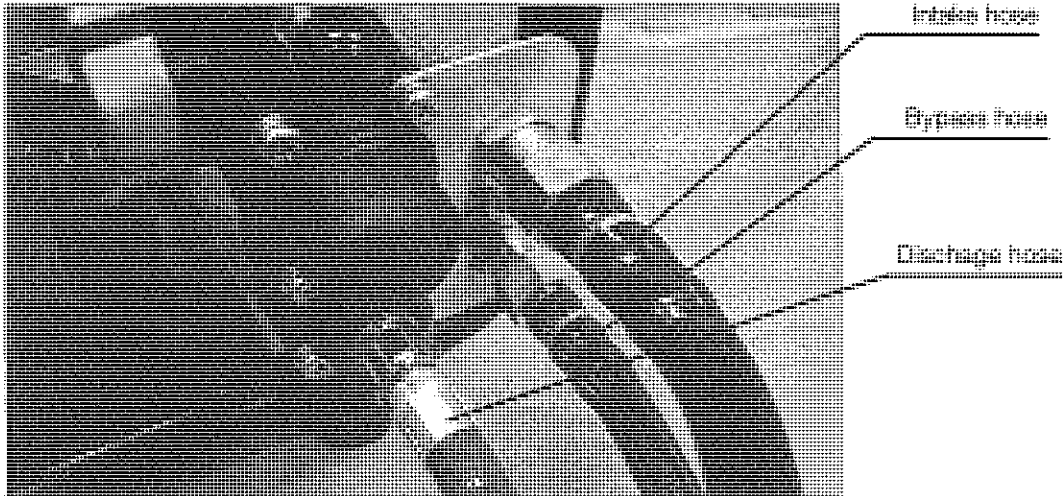

- 3) Remove the nozzle handle to disable spraying.

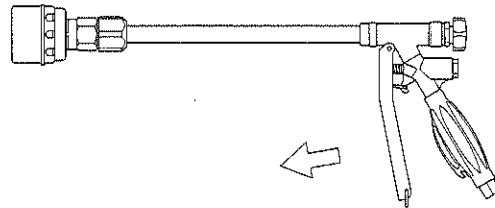

- 4) Before starting, make sure the pickup or intake hose is submerged in water. The water provides lubrication for the pump and will prevent damage to the pump.

- 5) Tie the water intake hose and bypass hose together with a band so that they will not pop out of the chemical liquid tank during operation.

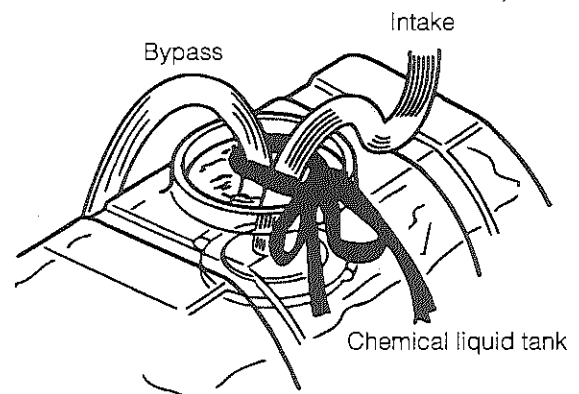

Gasoline is highly flammable and explosive. You can be burned or seriously injured when handling fuel. Stop the engine and keep heat, sparks, and flame away. Handle fuel only outdoors. Wipe up spills immediately.

Oil feeding and mixing

Oil feeding

- Make sure you use Fuel and oil mixture

Gasoline	:	exclusive oil
50	:	1

Use exclusive oil for two-cycle air cooled engines.

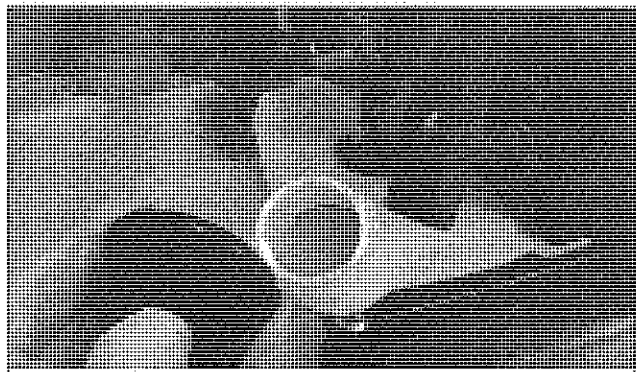

Neither overfill nor spill the fuel on to the engine.



DANGER

There is a possibility of fuel igniting. Make sure you observe the following items.

- When filling fuel, stop the engine and ensure no source of fire such as cigarette is close to the area.
- Don't spill fuel. If fuel is spilled, wipe it all off at once and start the engine after it is dry.
- Don't fill fuel above the standard line. There is the possibility of leakage.
- When a fuel leakage is found, use the engine after repairs are done.
- After filling fuel, make sure you close the fuel tank cap.

CAUTION

- If operating the machine with gasoline alone, the engine will seize. Make sure to mix exclusive two-cycle engine oil in the specified quantity.
- The mixing ratio shall be the designated ratio for exclusive two-cycle engine oil.
- Use lead-free gasoline for automobiles for fuel.

Start

Start of engine

CAUTION

When starting the engine, make sure to put water or chemicals into the chemical tank. Without water or chemicals in the tank, the pump will break down.

- 1 Perform priming. Push priming pump installed in front of the carburetor (rear in the specification with cell starter) several times slowly, and confirm that fuel fills the priming pump and returns to the tank.

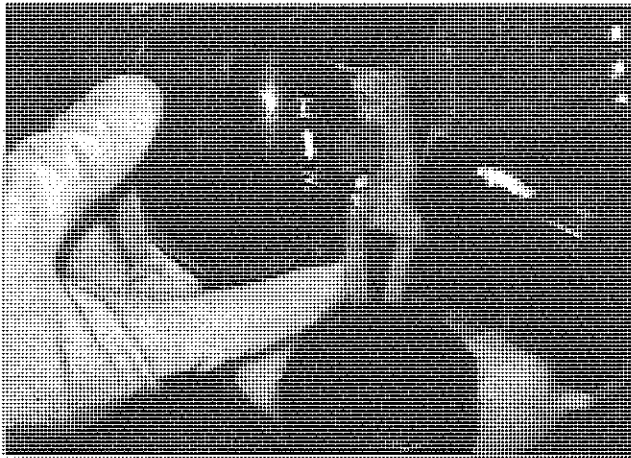

- 2 Fully close the choke. (In hot weather or when engine is hot, the choke should be partly open or fully open.)



- 3 Move throttle lever to medium-and low-speed position.

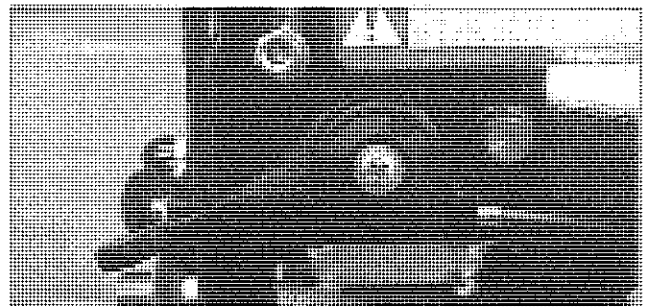

- 4 Set handle of pressure control valve at "Start" position.

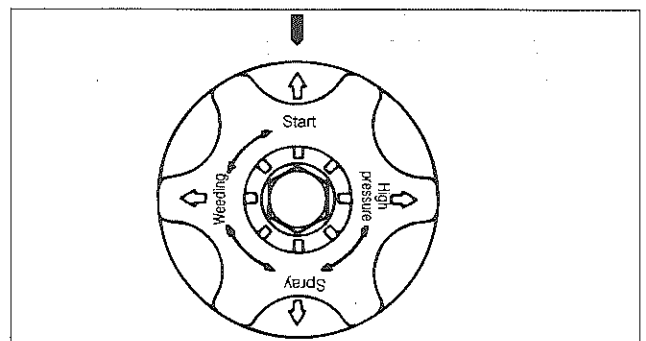

5 Engine will start.

After pulling starting rope gently by two or three times, pull it hard to start the engine.

[Pulling method for starting rope]

1. Grasp starting rope tight with right hand.
2. Hold chemical tank with left hand.
3. Pull starting rope slowly until resistance is felt.
4. Pull starting rope straight from entrance of starter.
5. Do not pull starting rope to the end.
6. Don't release starting rope from pulled state, and let it return to its original state gradually.

CAUTION

If the engine does not start by repeated action, try pulling the rope after fully opening the choke.

※ If the engine still does not start, refer to page 23.

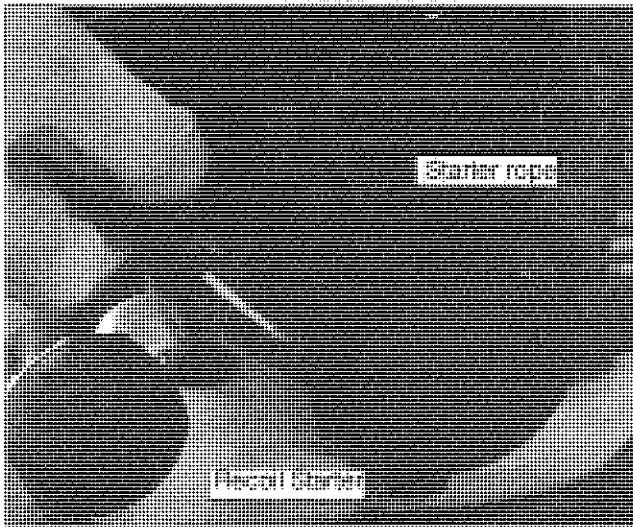

6 Return choke slowly.

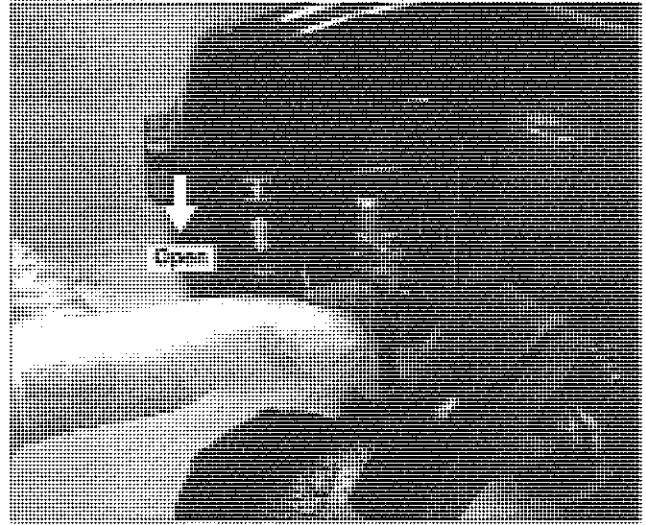

CAUTION

- Frequent operation of choke when starting the engine causes too much fuel to be sucked in, making the engine difficult to start. In that case, start after making the choke fully open.
- After starting the engine, accelerate bit by bit quickly by opening and closing the throttle lever several times.
- This operation is to bleed air in the carburetor. When there is air present, there is the possibility of poor acceleration and engine stalling.
- Supply fuel prior to use if possible. This will make starting next time easy.

Operation and shutting down

Operation

- 1 Turn the handle of the pressure control valve until there is sufficient pressure for work such as spraying weeds (fixed position).

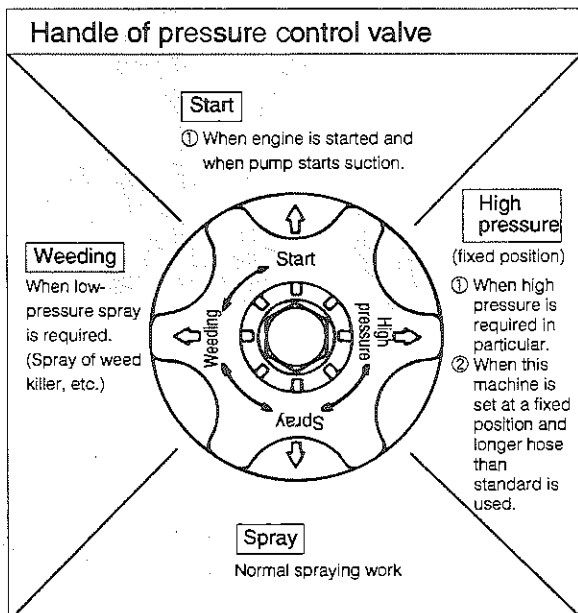

- 2 After confirming spraying state and abnormalities in the machine, move throttle lever to high-speed position.

CAUTION

- When setting the pressure control valve handle to "spray", "weeding" with throttle fully open at the "high pressure" position of pressure control valve handle, engine revolutions increase as pressure decreases. When using this machine at the "spray", "weeding" position, use at a position little bit back from full open throttle.
- No-load running shall not be carried out except for draining operation. Piston packing might be damaged.

- 3 When opening trigger valve, chemicals will be sprayed from nozzle in a mist.

Stop

- 1 Close the nozzle.

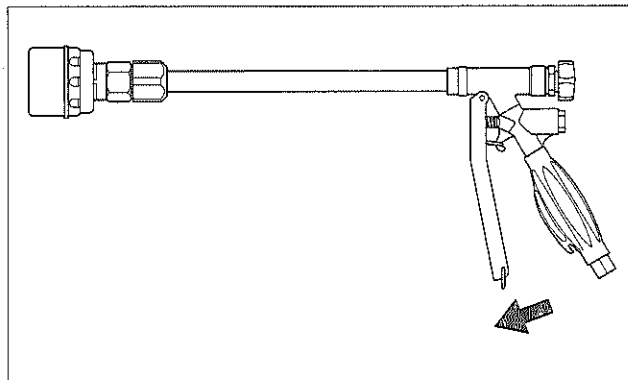

- 2 Return throttle lever to low speed.

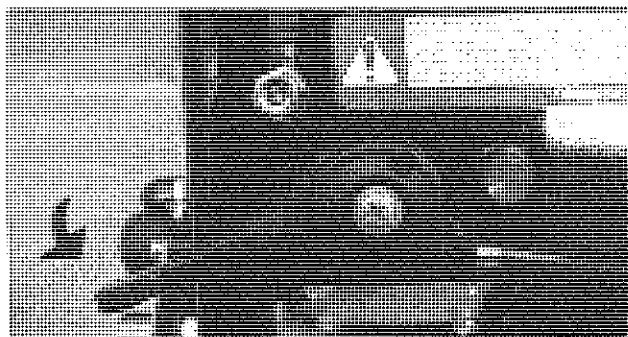

- 3 Push stop button to stop engine.

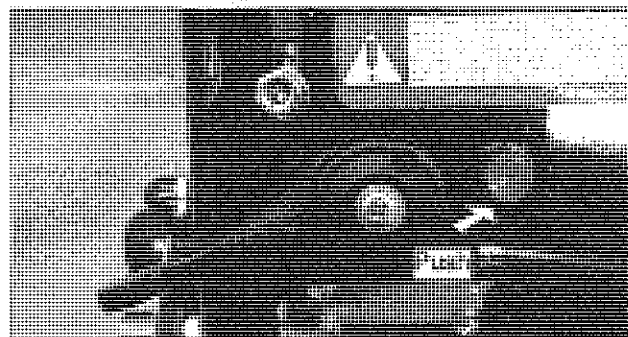

Throttle adjusting parameter

- (1) Always standard throttle position. (see fig 1)
※**For spraying , remove the stopper to standard position.**

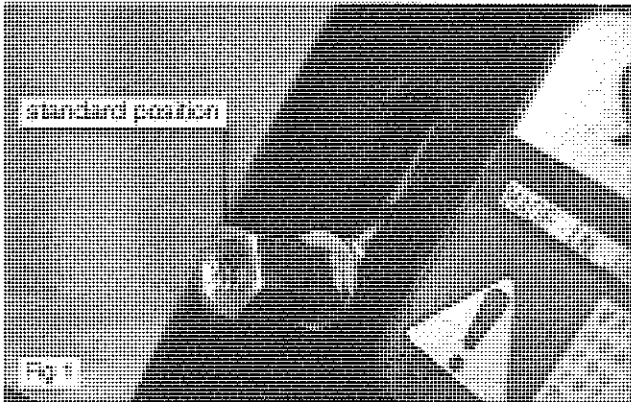

- (2) In order to perform full throttle , lose the stopper and remove to the top position.(see fig 2)
Must be tighten stopper. For long life spraying , prevent to be adjust stopper.

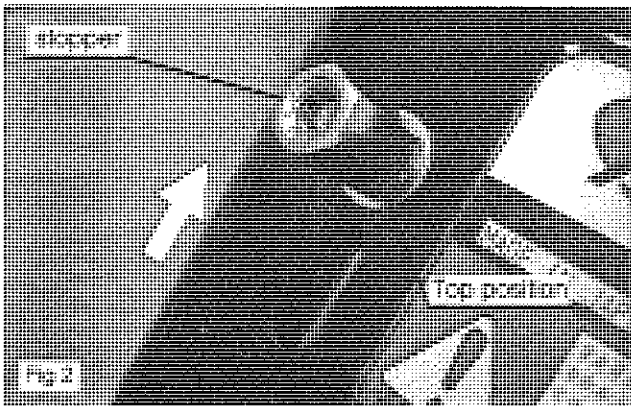

- (3) In order to perform standard setting , lose the stopper and remove to the standard position.(see fig 3)
Must be tighten the stopper.

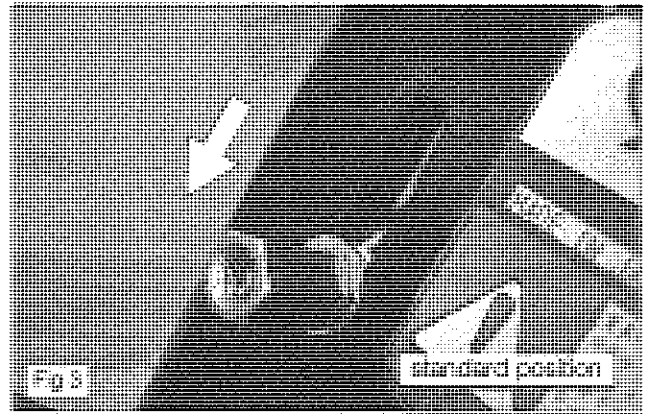

4. Cleaning, maintenance, and storage

Cleaning, maintenance and draining

For cleaning, checking and maintenance, be sure to stop the machine.

Check and maintenance items for each season

Air Filter Cleaning

1. Loosen the knob and remove the air filter cover.
2. Remove the foam element and filter screen from the air filter body.
3. Clean the foam element and filter screen with warm, soapy water. Let the screen and element dry completely.
4. Apply a light coat of SAE 30 motor oil to the foam element and squeeze out all excess oil.
5. Reassemble the filter screen and foam element to the air filter body.
6. Reinstall the air filter cover and tighten the knob.

1 Disassembly

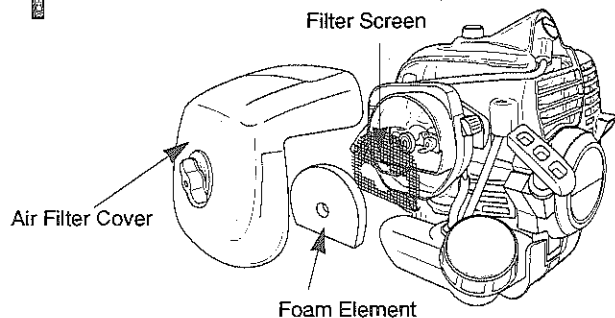

2 Clean

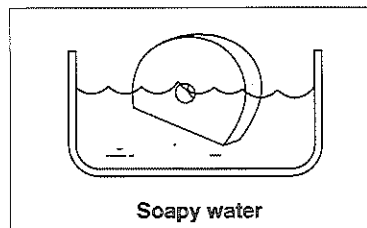

3 Squeeze

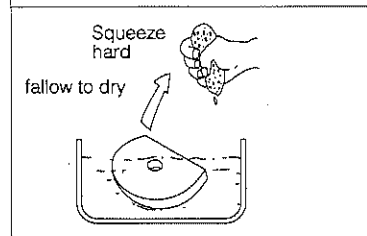

Cleaning ignition plug

- Remove carbon, and adjust the clearance to 0.6-0.7mm.

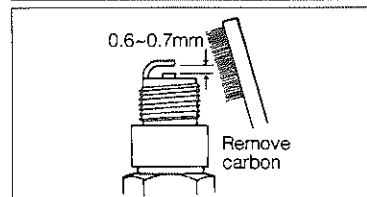

Pump

Check for worn piston packing and seal packing, and replace worn one with new one.

※ For disassembly and maintenance, consult with your authorized Maruyama service dealer.

Drain

CAUTION

Make sure to drain, otherwise the pump might be damaged by freezing in winter.

- ① Put fresh water into the chemical tank, start the engine, spray from the nozzle to clean the pump and inside of the hose.
- ② Remove the spray hose, water intake hose, and bypass hose from the machine. Drain the remaining liquid.
- ③ Operate for 15-20 seconds to drain residual liquid at the throttle lever position, which is a little bit back from full open position.
- ④ Set throttle lever at low speed, and stop the engine with the stop button.

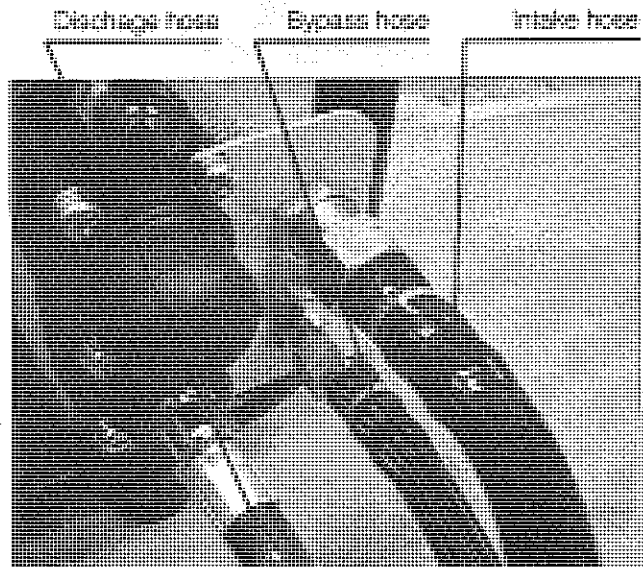

! CAUTION

Don't leave chemicals in the chemical tank and pump. This might cause damage to the machine.

Storage

1 Remove fuel from fuel tank, and operate the machine in idling state until it stops.

2 Set pressure control valve handle to "Start".

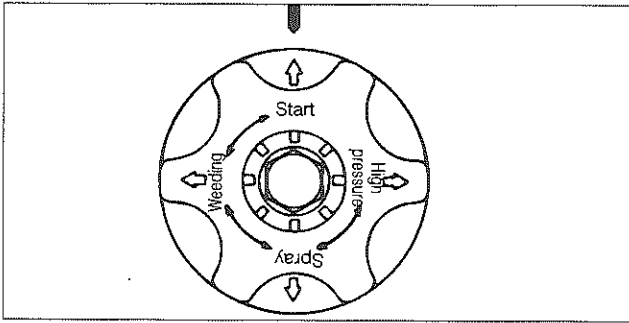

3 Move throttle lever to low-speed position.

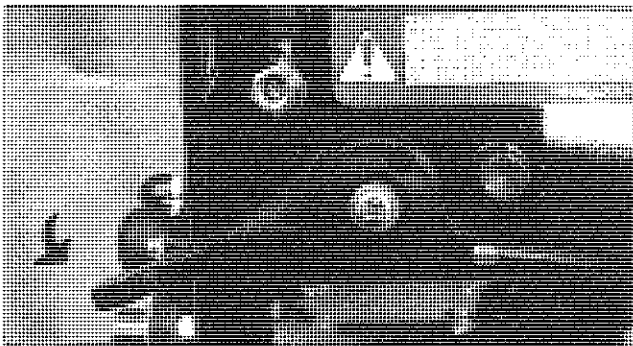

4 Maintenance of cylinder

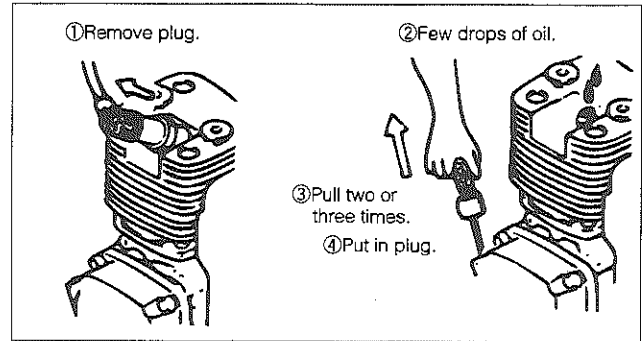

5 After finishing the above, put the machine in a box and store it at a place free from moisture and which is well ventilated.

CAUTION

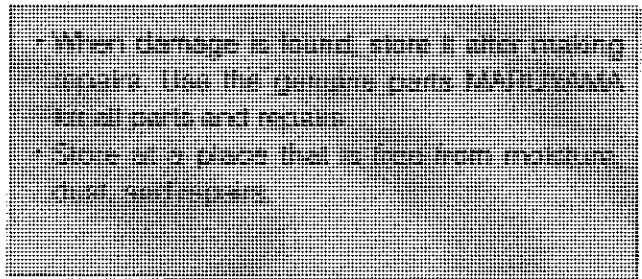

Trouble-shooting and actions

- When the pump or engine is not performing properly please refer to the following chart.
- Where marked with ☆, request adjustment or repair at authorized MARUYAMA servicing dealer.

Pump

Phenomena	Cause	Treatment	
Suck no water	(1) Loose connecting of suction hose (2) Suction hose clogged with chemicals (3) Wear to piston packing (4) Foreign matter in valve portion	(1) Tighten sufficiently. (2) Disassemble and clean (3) Replace with new parts (4) Disassemble and clean	☆ ☆ ☆
Pressure cannot be increased.(poor spraying state)	(1) Wear to piston packing (2) Scratch on the inside surface of cylinder (3) Scratch on delivery valve (4) Wear to pressure control valve seat (5) Foreign material on each valve (6) Wear to cam handle (7) Wear to nozzle hole (8) Too high a nozzle number used	(1) Replace with new one. (2) Replace with new one. (3) Replace with new one. (4) Replace with new one. (5) Disassemble and clean. (6) Replace with new one. (7) Replace with new one. (8) Decrease number of nozzles or replace with smaller diameter nozzle.	☆ ☆ ☆ ☆ ☆ ☆ ☆

Engine

Phenomena	Cause	Treatment	
Does not start	• No fuel • Fuel filter is clogged • Improper starting • Poor ignition plug • Poor magnet • Poor carburetor	• Supply fuel. • Clean • Refer item "Starting engine" • Replace. • Replace. • Replace.	☆ ☆ ☆
Insufficient output	• Poor adjustment of throttle wire • Clogging of air cleaner element • Carbon building up at exhaust port and muffler	• Adjust. • Clean. • Clean.	☆ ☆
Excessive Vibration	• Loose parts	• Tighten	
Excessive Vibration	• Loose muffler and muffler cover	• Tighten	

5. Specification

Dimension	
Height×Width ×Length(mm)-(inches)	350×275×325(13.8×10.8×12.8)
Dry weight(kg) (lbs)	7.1 (15.3)
Total weight(kg) (lbs)	10.4 (22.9)
Fuel tank capacity(ℓ) (gallons)	0.6 (0.16)
Pump	
Type	Maruyama twin uni-flow
Maximum pressure(kgf/cm ²) (PSI)	25 (357)
Suction(ℓ/min) (gallons/min)	7.5 (1.98)
Rotational frequency(rpm)	1930
Engine	
Model	MARUYAMA CER300
Type	Forced Air Cool, 2-cycle
Displacement(mℓ)	30.1
Rated continuous output(PS/rpm)	1.3/7500
Fuel	Mixed gasoline(50 : 1)
Ignition system	Electronic Ignition
Spark plug	NGK BPM 6Y
Starting system	Recoil Starter

The specification may be changed for product improvement, without prior notice.

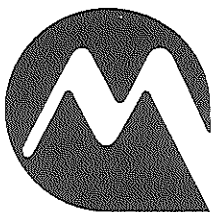

Maruyama U.S., Inc.
3570 Shelby Lane
Denton, TX 76207 U.S.A
Phone 940-383-7400
Fax 940-383-7466
www.maruyama-us.com
130922-00 11.09 TAP/M