

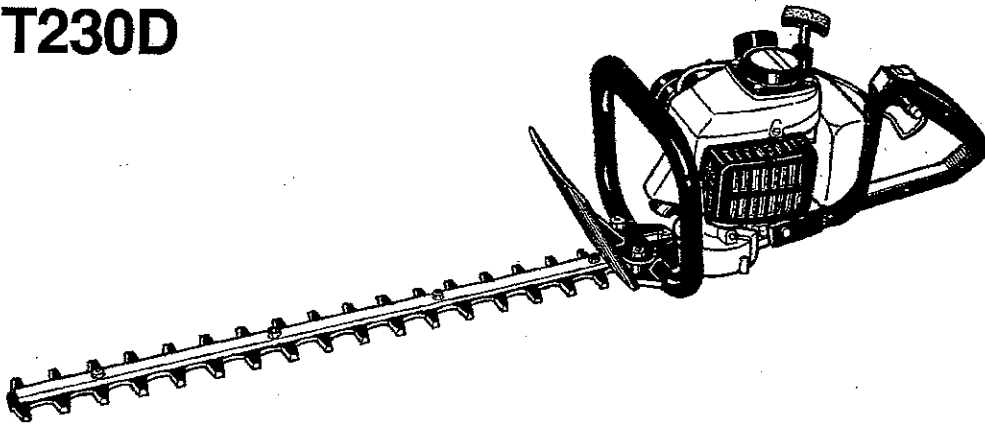

**HT230D**

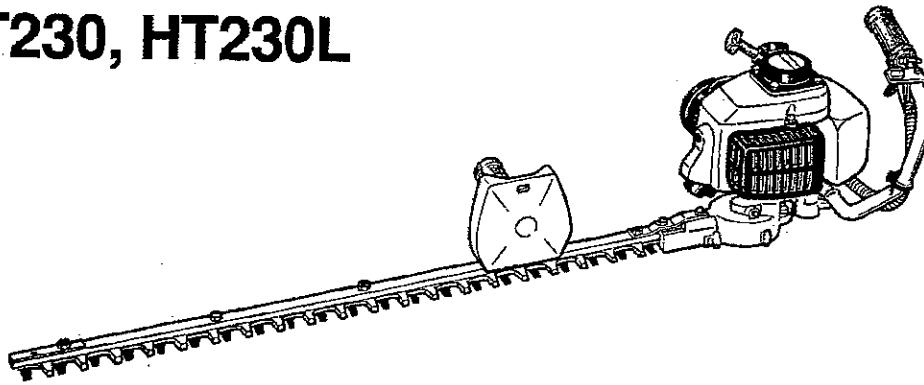

**HT230, HT230L**



# Owner's/Operator's Manual

Completely read and understand this manual before using this product.



## Limited Warranty Statement

All Maruyama products are warranted to the original purchaser to be free from defects in material and workmanship **from the date of purchase** for the time periods listed as follows:

**Lifetime** for inner drive shafts on trimmers and brushcutters and all ignition modules. **3 years** for residential, non-institutional, non-income producing use. **2 years** for industrial, commercial, institutional and income producing use. **1 years** for rental use.

Any part of a Maruyama product found to be defective within the applicable warranty period shall, at Maruyama's option, be repaired or replaced without charge. Warranty consideration is obtained by delivering any Maruyama product believed to be defective to an Authorized Maruyama Servicing Dealer within the applicable warranty period.

The purchaser shall not be charged for diagnostic labor that leads to the determination that a warranted part is defective, if the diagnostic work is performed at a Maruyama Dealer.

Any warranted part which is not scheduled for replacement as required maintenance, or which is scheduled only for regular inspection to the effect of "repair or replace as necessary" shall be warranted for the warranty period. Any warranted part which is scheduled for replacement as required maintenance shall be warranted for the period of time up to the first scheduled replacement point for that part. Maruyama Mfg. Co., Inc. is liable for damages to other engine components caused by the failure of a warranted part still under warranty.

The purchaser is responsible for the performance of the required maintenance, as defined by Maruyama Mfg. Co., Inc. in the Owner's/Operator's Manual.

**EMISSION-RELATED PARTS WARRANTY:** In addition to the above warranty coverage, Maruyama Mfg. Co., Inc. will repair or replace, free of charge, for the original purchaser and each subsequent purchaser any emission-related part or parts found to be defective in material and workmanship for two (2) years from original retail delivery date. **Emission-related parts are the carburetor assembly, the ignition coil assembly, the ignition rotor and the spark plug.** Any replacement part that is equivalent in performance and durability may be used in non-warranty maintenance or repairs, and shall not reduce the warranty obligations of Maruyama Mfg. Co., Inc.

### **This warranty does not cover the following:**

1. Maintenance items (excluding defects in materials and workmanship) including hoses, spark plugs, starter rope, air and fuel filters, vibration isolators, throttle cables and all cutting attachments.
2. Extra expenses including shipping and handling, travel, payment for lost time or pay and for any inconvenience and storage.
3. Alterations or modifications including aftermarket parts not authorized by Maruyama U.S., Inc.
4. Wear, accident, abuse, neglect, misuse, negligence, improper fuels, lubricants, fuel mixtures (when applicable), or failure to operate or maintain the product in accordance with instructions approved by Maruyama.

Repair or replacement as provided under this warranty is the exclusive remedy of the consumer. Maruyama shall not be liable for any incidental or consequential damages for breach of any express or implied warranty on these products except to the extent prohibited by applicable law. Any implied warranty of merchantability or fitness for a particular purpose on these products is limited in duration to the warranty period as defined in the limited warranty statement. Maruyama reserves the right to change or improve the design of the product without notice and does not assume obligation to update previously manufactured products.

This warranty provides you with specific legal rights which may vary from state to state.

It is the Owner's and Dealer's responsibility to make sure the Warranty Registration Card is properly filled out and mailed to Maruyama U.S., Inc. Proof of purchase and registration will be required in order to obtain warranty service.

To locate an Authorized Maruyama Servicing Dealer nearest you, contact Maruyama U.S., Inc. at **1-253-735-7368**.

Maruyama U.S., Inc.  
PO Box 309  
Auburn, WA 98071-0309

Effective October 1, 1994

# FOREWORD

This Owner's/Operator's Manual is designed to familiarize the operator with the various features and component parts of the equipment and to assist you with the operation and maintenance of your new Hedge Trimmer.

**It is essential that any operator of this Hedge Trimmer product reads and understands the contents of this manual before using the Hedge Trimmer.**

Important safety instructions will be identified by the following safety symbol:



Failure to comply with the instructions in this manual may result in serious injury or death.

For additional assistance, contact any local authorized Maruyama dealer or Maruyama U.S., Inc., 301 – 30<sup>th</sup> St. NE, Suite 118, Auburn, WA 98002.

## TABLE OF CONTENTS

Warranty .....	1	Starting and stopping procedure .....	9
Foreword .....	2	Carburetor adjustment .....	11
Specifications .....	2	Operating the Power Hedge Trimmer .....	11
Product description .....	3	Regular maintenance .....	12
Safety instructions .....	4	Storage .....	15
Before operation .....	7		

## SPECIFICATIONS

Models	HT230D	HT230	HT230L
Length x Width x Height	1030 x 220 x 240 mm (40.5 x 8.7 x 9.4 in.)	1060 x 280 x 240 mm (41.7 x 11 x 9.4 in.)	1410 x 280 x 240 mm (55.5 x 11 x 9.4 in.)
Dry Weight	5.0 kg (11.0 lbs.)	5.3 kg (11.8 lbs.)	5.9 kg (12.9 lbs.)
Blade Length	24 in.	30 in.	40 in.
Engine Model	LE230		
Engine Displacement	22.5 cc		
Fuel Tank Capacity	0.5 l (0.53 qts.)		
Carburetor	Walbro Diaphragm Type		
Ignition System	Solid State		
Spark Plug:			
Make	NGK		
Type	BPM6Y		
Electrode Gap	0.6 ~ 0.7 mm (0.024 ~ 0.028 in.)		
<b>Fuel Mixture:</b>			
Using Maruyama 50:1 2-Cycle Engine Oil.	50:1		
Using other 2-cycle engine oils designed for air-cooled 2-cycle engines.	25:1		

# PRODUCT DESCRIPTION

## MODEL: HT230D

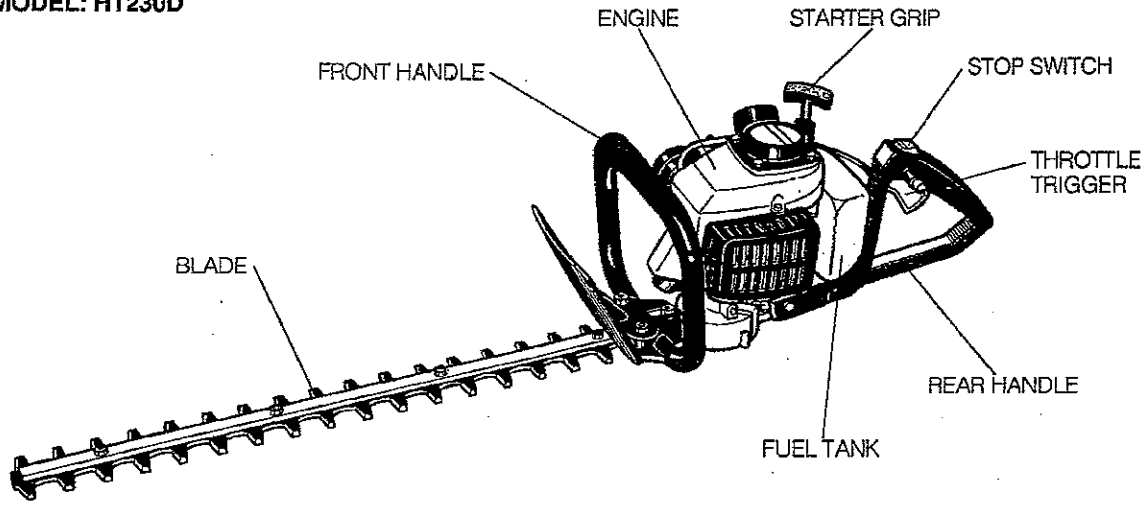

## MODELS: HT230 AND HT230L

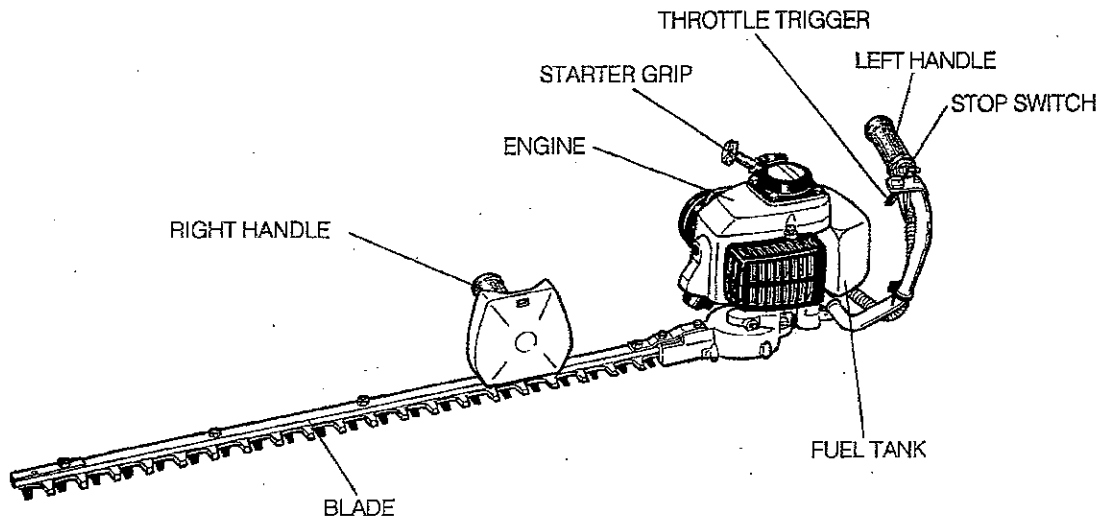

**⚠ WARNING: ⚠**  
The engine exhaust from this product contains chemicals known to the State of California to cause cancer, birth defects or other reproductive harm.



## SAFETY INSTRUCTIONS



### Operator safety

1. Read and understand this Owner's/Operator's Manual before using this product. Be thoroughly familiar with the proper use of this product.
2. Always wear eye protection that complies with ANSI (American National Standards Institute) Z87-1.
3. Wear hearing protection.
4. Always wear heavy, long pants, boots and gloves. Do not wear loose clothing, jewelry, short pants, sandals or go barefoot. Secure hair so it is above shoulder length.

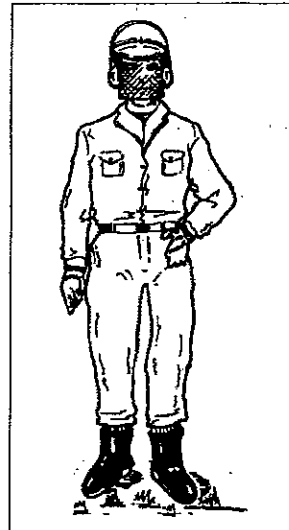

5. Never operate this Hedge Trimmer when you are tired, ill under the influence of alcohol, drugs or medication.
6. Never start or run the engine inside a closed room or building. Breathing exhaust fumes can cause death.

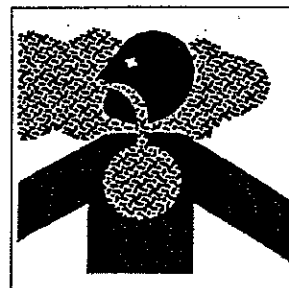

7. Keep handles clean of oil, fuel and dirt.

### Power Hedge Trimmer safety

1. Shut off the engine and wait until the cutting blades have completely stopped moving before checking, maintenance or working on the Hedge Trimmer.
2. Inspect the Hedge Trimmer before each use. Replace damaged parts. Check for fuel leaks. Make sure all fasteners are in place and tightened securely. Follow the maintenance instructions provided on pages 12 to 14 of this manual.
3. Inspect the Hedge Trimmer cutting blades and guide. Replace any parts that are cracked, chipped, or damaged before using the power Hedge Trimmer.
4. Never use replacement parts that are not approved by Maruyama U.S., Inc.
5. Maintain the Hedge Trimmer in accordance with the recommended maintenance intervals and procedures in the maintenance section, pages 12 to 14.
6. If running problems or excessive vibration occur, stop immediately and inspect the unit for the cause. If the cause cannot be determined or is beyond your ability to correct, return the Hedge Trimmer to your servicing dealer for repair.

### Fuel safety

1. Gasoline is highly flammable and must be handled and stored carefully. Use a container approved for storing gasoline and /or fuel/oil mixture.

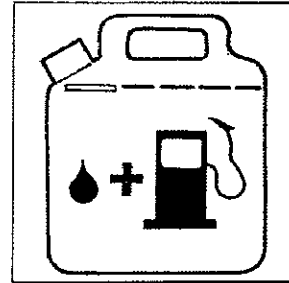

2. Mix and pour fuel outdoors and where there are no sparks or flames.
3. Do not smoke near fuel or the Hedge Trimmer or while using the Hedge Trimmer.
4. Do not overfill the fuel tank. Stop filling 1/4-1/2 inch from the top of the tank.
5. Wipe up any spilled fuel before starting the engine.



6. Move the Hedge Trimmer at least 10 feet (3m) away from the fueling location before starting the engine.
7. Do not remove the Hedge Trimmer fuel tank cap while the engine is running or right after stopping the engine.
8. Allow the engine to cool before refueling.
9. Empty the fuel tank before storing the Hedge Trimmer. Fuel should be emptied after each use. Fuel left in the tank during storage may leak.
10. Store fuel and Hedge Trimmer away from open flame, sparks and excessive heat. Make sure fuel vapors cannot reach sparks or open flames from water heaters, furnaces, electric motors, etc.

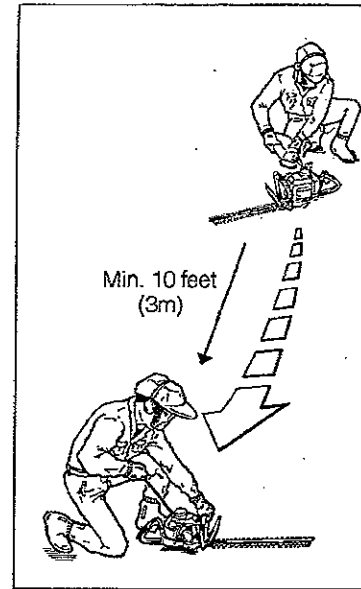

### **Power Hedge Trimmer operating safety**

1. **THIS HEDGE TRIMMER CAN CAUSE SERIOUS INJURIES.**  
Read the instructions carefully. Be familiar with all controls and the proper use of the Hedge Trimmer.
2. Never allow children to operate the Hedge Trimmer. It is not a toy.
3. Keep the area of operation clear of all persons, particularly small children and pets.
4. The Hedge Trimmer blades are extremely sharp. Do not put hands or feet near or under any moving parts. Keep body clear at all times.
5. Use the Hedge Trimmer only in daylight or good artificial light.
6. Inspect your work area before you begin. Remove string, rope or similar materials which can become entangled in the Hedge Trimmer blades.
7. Avoid hidden hazards. Watch for hidden objects within your working area, such as chain link fencing, cables, wires, telephone and power lines.
8. Never operate the Hedge Trimmer without proper guards or other protective safety devices in place.
9. Keep firm footing and balance. Do not over-reach. Do not operate the Hedge Trimmer while standing on a ladder or similar temporary support.
10. Use the right tool for the job. Do not use the Hedge Trimmer for any job that is not recommended by the manufacturer.

# BEFORE OPERATION

## FUELING

**WARNING!** The following precautions will lessen the risk of fire.

1. Do not smoke near fuel.
2. Mix and pour fuel outdoors and where there are no sparks or flames.
3. Always shut off the engine before refueling. Never remove the Hedge Trimmer fuel tank cap while the engine is running or right after just stopping the engine.
4. Always open the fuel tank cap slowly to release any possible overpressure inside the tank.
5. Do not overfill the fuel tank. Stop filling 1/4-1/2 inch from the top of the tank.
6. Tighten the tank fuel cap carefully but firmly after refilling.
7. Wipe up any spilled fuel before starting the engine.
8. Move the Hedge Trimmer at least 10 feet away from the fueling location and fuel storage container before starting the engine.

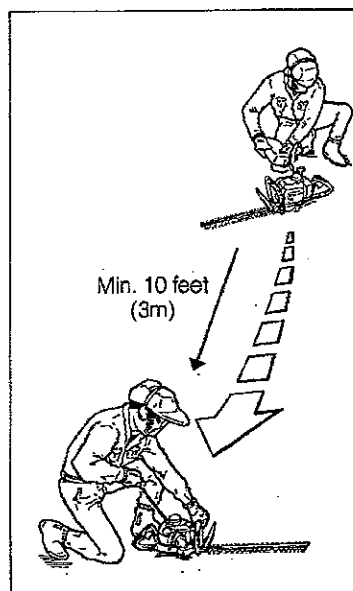

## FUEL: MIXING GASOLINE AND OIL

**WARNING!** The engine used on this Hedge Trimmer is of a 2-cycle design. The internal moving parts of the engine, i.e., crankshaft bearings, piston pin bearings and piston to cylinder wall contact surfaces, require oil mixed with the gasoline for lubrication. Failure to add oil to the gasoline or failure to mix oil with the gasoline at the appropriate ratio will cause major engine damage which will void your warranty. For your fuel premix, only use Maruyama 50:1 2-Cycle Oil or a quality oil designed for 2-cycle air cooled engines.

**FUEL MIXTURE:** When using genuine Maruyama 50:1 2-Cycle Oil, the fuel:oil ratio is 50 parts gasoline to 1 part oil or 50:1. If Maruyama 2-cycle engine oil is not available, use a good quality 2-cycle, air-cooled engine oil mixed at a ratio of 25:1.



**NOTE: If Maruyama oil is not used, never use a mixing ratio less than 50:1 regardless of the oil package mixing instructions. Ratios less the 50:1, (for example, 60:1, 80:1, 100:1), reduce the amount of lubrication to the internal moving parts of the engine and can cause damage.**

**FUEL MIXTURE CHART:**

Gasoline	Maruyama 50:1 2-Cycle Oil	Gasoline	Other brands of 2-cycle oil
1 gallon	2.6 oz.	1 gallon	5.2 oz.
2 1/2 gallons	6.4 oz.	2 1/2 gallons	12.8 oz.
5 gallons	12.8 oz.	5 gallons	25.6 oz.

**MIXING INSTRUCTIONS:** Always mix fuel and oil in a clean container approved for gasoline. Mark the container to identify it as fuel mix for the Hedge Trimmer. Use regular unleaded gasoline and fill the container with half the required amount of gasoline. Pour the correct amount of oil into the container then add the remaining amount of gasoline. Close the container tightly and shake it momentarily to evenly mix the oil and the gasoline before filling the fuel tank on the Hedge Trimmer.

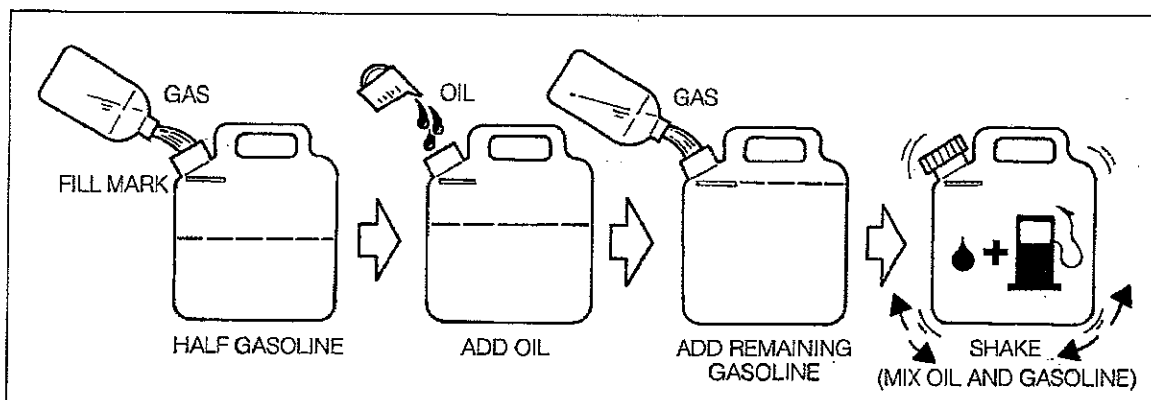

When refilling the Hedge Trimmer fuel tank, clean around the fuel tank cap to prevent dirt and debris for entering the tank during cap removal. Always shake the premix fuel container momentarily before filling the fuel tank.

Always use a spout or funnel when fueling to reduce fuel spillage. Only fill the tank to within 1/4-1/2 inch from the top of the tank. Avoid filling to the top of the tank filler neck.

**NOTE:**

1. Never mix gasoline and oil directly in the Hedge Trimmer fuel tank.
2. Do not use National Marine Manufacturer's Association (NMMA) or BIA certified oils. This type of 2-cycle engine oil does not have the proper additives for air-cooled, 2-cycle engines and can cause engine damage.
3. Do not use automotive motor oil. This type of oil does not have the proper additives for air-cooled, 2-cycle engines and can cause engine damage.

## **ADJUSTING THE CUTTING BLADES**



**CAUTION-DO NOT TOUCH THE SHARPENED EDGES OF THE CUTTING BLADES. THE CUTTING BLADES ARE EXTREMELY SHARP AND DANGEROUS AT ALL TIMES. ALWAYS WEAR GLOVES TO HELP PROTECT YOUR HANDS AND FINGERS FROM INJURY.**

Before operating the Hedge Trimmer it is necessary to check the adjustment of the cutting blades. Blades that are too loose may vibrate, and will not provide a clean, smooth cut.



**CAUTION-BLADES THAT ARE TOO TIGHT CAN CAUSE OVERLOADING WHICH MAY DAMAGE THE EQUIPMENT.**

To adjust the cutting blades, refer to the illustration and locate the screws.

Loosen the nuts.

Gently turn the screws in until snug, then turn the screws back out one-fourth to a half. While holding the screws in place, tighten the nuts. Liberally coat the cutting blades with light oil. Start the engine and operate the Hedge Trimmer at full speed for at least one minute. Stop the engine, and when the blades are motionless, touch the blades with your hand.

The blades should be warm, but if they are too hot to touch, loosen the screws another 1/8 turn.

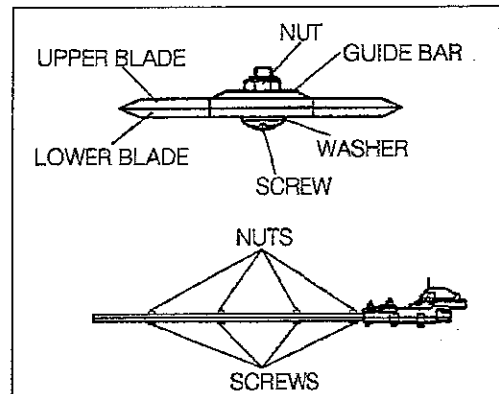

## **STARTING AND STOPPING PROCEDURE**

**Before Starting The Engine:** Fill the fuel tank as instructed in the BEFORE OPERATION section of this manual. Rest the Hedge Trimmer on the ground. Make sure that the cutting blades are clear of branches, shrubs, debris, etc. Keep all bystanders, children and animals away from the working area.

### **Maruyama Hedge Trimmer Idle Start System:**

This Maruyama Hedge Trimmer is equipped with a fuel primer and idle start system. The fuel primer and idle start systems make the Maruyama Hedge Trimmer extremely easy to start regardless of the engine and/or ambient temperature.

The fuel primer draws fuel from the tank up to and through the carburetor where it initially primes (fills) all of the fuel passages while forcing out air. The air and excess fuel is returned to the fuel tank through the fuel return hose. **The fuel priming system does not allow fuel to flow into the engine** so it is not possible to over prime or flood the engine regardless of the number of times the fuel primer bulb is depressed.

**Maruyama's idle start (fuel enrichment) system is superior to a choke starting system.** With choke equipped 2-cycle engines, it is usually necessary to lock the throttle partially open during starting to reduce the risk of flooding the engine with fuel. You then have to close the choke and pull the starter grip until the engine tries to start. Then you have to open the choke and pull the starter grip again until the engine starts and runs.

This also means that when the engine starts, it will be running above idle or clutch engagement speed causing the Hedge Trimmer blades to move.

With Maruyama's idle start system it is not necessary nor recommended to partially open the throttle during starting. Rotating the cold starting lever to the locked position lifts the needle jet permitting a metered amount of extra fuel to enter the engine during starting. After the engine starts, one squeeze of the throttle trigger returns the cold start lever to the off position and the Hedge Trimmer is ready for use.

### To Start A Cold Engine:

1. Push and release the fuel primer bulb located on the bottom of the carburetor until air bubble free fuel is seen flowing through the clear fuel return hose back to the fuel tank.

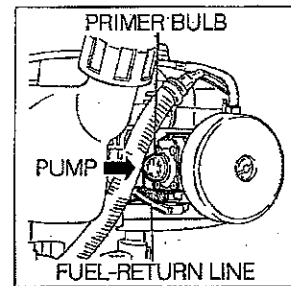

2. Rotate the cold start lever about a quarter turn clockwise to the locked position. **Do not depress the throttle trigger.** Depressing the throttle trigger before the engine starts will automatically return the cold start lever to the off position.

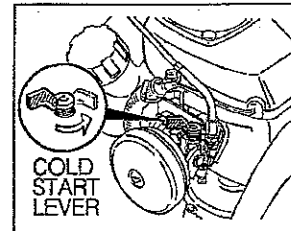

3. Set the engine stop switch to the "ON" position. Pull the starter grip until the engine starts. Once the engine is running, depress and release the throttle trigger quickly to automatically return the cold start lever to the off position. If the engine stalls before you depress the throttle trigger, depress and release the throttle trigger to return the cold start lever to the off position, then pull the starter grip until the engine starts.

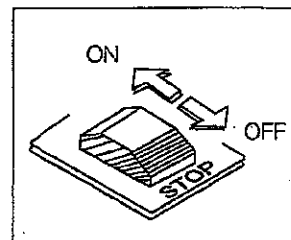

### To Start A Warm Engine:

1. Push and release the fuel primer bulb located on the bottom of the carburetor until air bubble free fuel is seen flowing through the clear fuel return hose back to the fuel tank.
2. Set the engine stop switch to the "ON" position. With the throttle trigger in the idle running position, pull the starter grip until the engine starts. If the engine fails to start after 3 or 4 pulls on the starter grip, follow steps 2 and 3 in the previous **To Start A Cold Engine** section.

### To Stop The Engine:

1. Release the throttle trigger.
2. Slide the stop switch to the "STOP" position.

## CARBURETOR ADJUSTMENT

This Hedge Trimmer is equipped with non-adjustable fuel mixture carburetor. The engine idle speed is the only adjustment to the Operator.

The cutting blades may be moving during idle speed adjustment. Wear the recommended personal protective equipment and observe all safety instructions. Keep hands and body away from blade area.

### Engine Idle Speed:

When the throttle trigger is released the engine should return to an idle speed which is 2700-3300 rpm or just below clutch engagement speed. The cutting blades must not move and the engine should not stall (stop running) at engine idle speed.

The engine idle speed is adjusted by rotating the idle speed screw on the carburetor. Turning the idle speed screw in (clockwise) increases engine speed while turning the screw out decreases engine speed.

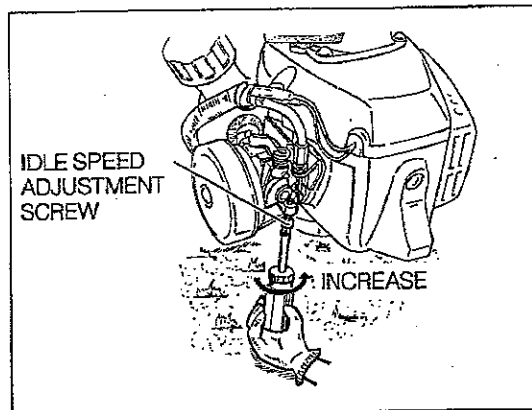

If idle speed adjustment is necessary and after adjustment the cutting blades move or the engine stalls, **stop using the Hedge Trimmer immediately!**

Contact your local authorized Maruyama Dealer for assistance and servicing.

## OPERATING THE POWER HEDGE TRIMMER



**CAUTION**-Read the *SAFETY INSTRUCTIONS* on page (4) concerning the proper use of the Hedge Trimmer.

The MARUYAMA Hedge Trimmer is designed for cutting and trimming foliage and small branches up to 1/4 inches in diameter. Although the MARUYAMA Hedge Trimmer is capable of cutting larger diameter branches, wear and tear of the machine would be proportionally increased.



**CAUTION**-Always wear gloves and protective clothing when operating the Hedge Trimmer.

If the cutting blades become jammed, stop the engine immediately. Make certain all moving parts have stopped and disconnect the spark plug before inspecting the equipment for damage. Never use a Power Hedge Trimmer that has chipped, cracked, or broken cutting blades.

## REGULAR MAINTENANCE

### AIR FILTER

**Maintenance Interval:** The air filter should be cleaned daily or more often when working in extremely dusty conditions and replaced after every 100 hours of operation.

**Maintenance:** Remove the air filter cover by unscrewing the single cover retaining screw. Remove the foam filter. Clean the filter with warm, soapy water. Let the filter completely dry. Lightly apply SAE 30 motor oil to the foam filter and squeeze out all excess oil. Reassemble the filter and filter cover.

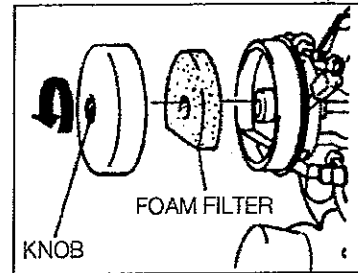

### FUEL FILTER

**Maintenance Interval:** The fuel filter should be replaced after every 100 hours of operation.

**Maintenance:** The fuel filter is attached to the end of the fuel pick-up hose inside the fuel tank. To replace the fuel filter, first make sure the fuel tank is empty. Remove the fuel cap. Using a wire hook, gently pull the fuel filter out through the fuel filter opening. Grasp the fuel hose next to the fuel filter fitting and remove the filter **but do not release the hose**. While still holding on to the fuel hose, attach the new fuel filter. Drop the fuel filter back into the fuel tank. Make sure that the fuel filter is not stuck in a corner of the tank and that the fuel hose is not doubled over (kinked) before refueling.

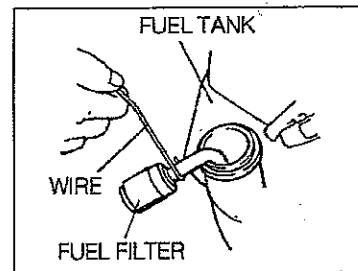

### SPARK PLUG

**Maintenance Interval:** The spark plug should be removed from the engine and checked after each 25 hours of operation and replaced after every 100 hours of operation.

**Maintenance:** With the engine at ambient (room) temperature, remove the one screw retaining the muffler cover, then remove the muffler cover. Loosen the cylinder cover screw and lift off the cylinder cover. (Refer to the illustration shown in the following CYLINDER COOLING FINS section.) Twist the high tension lead boot on the spark plug back and forth a couple of times to loosen boot then pull the boot off of the spark plug. Remove the spark plug. The electrodes can be cleaned with a stiff brush. Adjust the electrode air gap to 0.6–0.7 mm (0.024–0.028 in.). Replace the spark plug if it is oil-fouled, damaged or if the electrodes are worn down. **Do not overtighten the spark plug when installing.** The tightening torque is 10.7–16.6 Nm (95–148 in. lbs.). Reinstall the cylinder and muffler covers.

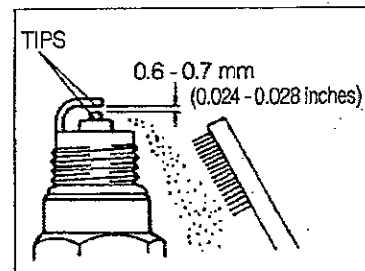

## **AIR INLET SCREENS**

The engine used on the HT230, HT230D and HT230L hedgetrimmers is fitted with air inlet screens on either side of the crankcase behind the flywheel. Air is pulled through these screens by the fins on the flywheel then blown around the cylinder to cool the engine. Large pieces of debris such as leaves and other types of clippings can plug up the screens reducing or completely stopping this air flow which can cause the engine to overheat. Severe engine damage is likely to occur if the engine continuously overheats. The screens must be inspected and if necessary, cleaned on a regular basis.

**Maintenance Interval:** Inspect the screens before each use. If leaves, grass, dirt or debris is visible, clean the screens according to the following Maintenance information.

**Maintenance:** With the engine cool (ambient or room temperature), remove the one screw retaining the muffler cover. Both screens should now be accessible. It is not necessary to remove the screens for cleaning. Dirt and debris can be removed from the screens using a suitable pair of pliers. (Pictures are okay)

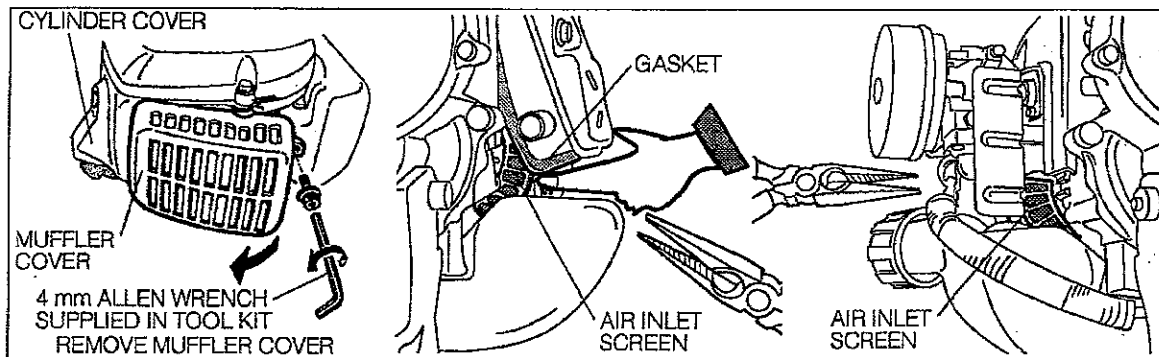

## **CYLINDER COOLING FINS**

**Maintenance Interval:** The cylinder cooling fins should be cleaned after every 25 hours of operation or once a week whichever comes first. Air must flow freely around and through the cylinder cooling fins to prevent engine overheating. Leaves, grass, dirt and debris buildup on the fins will increase the operating temperature of the engine which can reduce engine performance and shorten engine life.

**Maintenance:** With the engine at ambient (room) temperature, remove the one screw retaining the muffler cover, then remove the muffler cover. Loosen the cylinder cover screw and lift off the cylinder cover. Clean all dirt and debris from the cooling fins and from around the cylinder base. Reinstall the cylinder cover and the muffler cover.

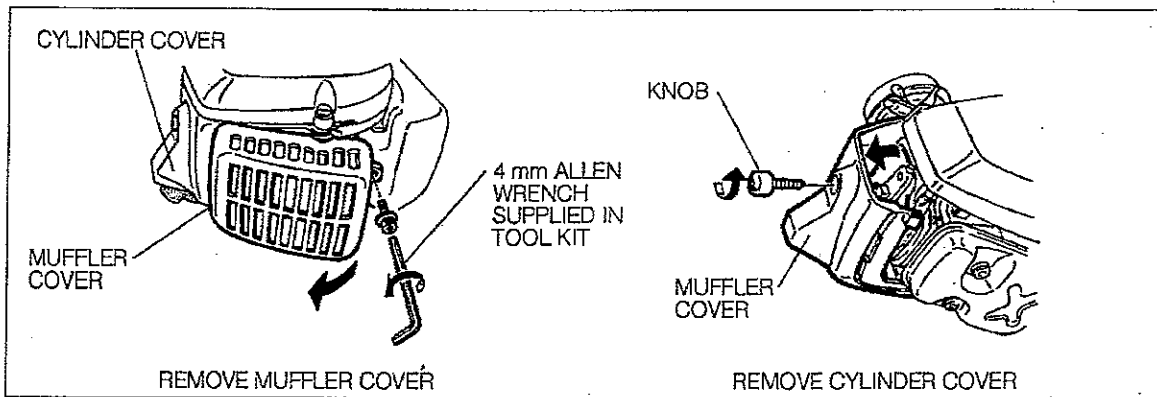

## **SPARK ARRESTER**

**Maintenance Interval:** The spark arrester should be inspected and cleaned after every 25 hours of use. Replace the screen if it cannot be thoroughly cleaned or if it is damaged.

**Maintenance:** The spark arrester is installed inside the exhaust outlet of the muffler. One screw located on the side of the exhaust outlet holds the spark arrester in place. To remove the spark arrester, first remove the one screw retaining the muffler cover, then remove the muffler cover. Remove spark arrester retaining screw, then using a suitable pair of pliers, withdraw the spark arrester. Do not crush or distort the spark arrester flange during removal.

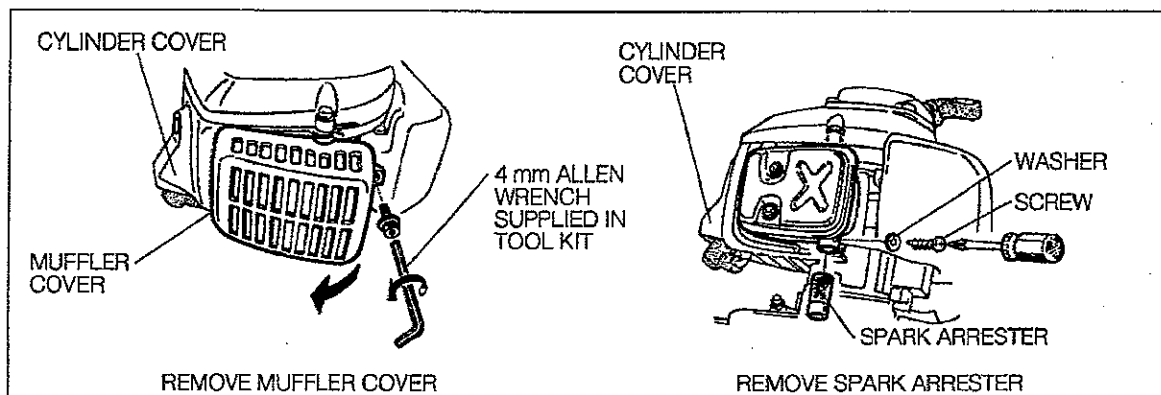

## **LUBRICATION : GEARCASE AND BLADES**

The gearcase has a felt wick located at the blade opening. As the Hedge Trimmer is used, the grease within gearcase becomes very soft. The reciprocating blades constantly draw small amounts of grease between the blade contact surfaces for additional lubrication. If the gearcase is not lubricated at the recommended intervals, a gearcase failure will occur due to a lack of lubrication.

Gearcase failures due to improper maintenance is not covered by Maruyama warranty.

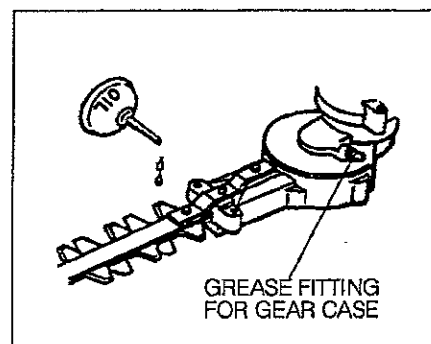

The gearcase and blades should be lubricated after each 10 hours of use.

**NOTE:** If the Hedge Trimmer is used under severe conditions such as high ambient temperatures (above 75°F) or for extended continuous periods of operation, the gearcase and blades must be lubricated every 2 hours.

Lubricate the gearcase at the grease fitting with a good quality #2 lithium-base grease. Lubricate the blades using a light (#10 wt.) oil.

## **GENERAL CLEANING AND TIGHTENING**

The MARUYAMA Hedge Trimmer will provide maximum performance for many, many hours if it is maintained properly. Good maintenance includes regular checking of all fasteners for correct tightness, and cleaning of the entire machine. Pitch and gum deposits should be removed from the cutting blades daily. Adjustment of the cutting blade tension should be checked regularly. Refer to page (9) for instructions to adjust cutting blades.

## **STORAGE**

For long-term storage of the Hedge Trimmer, empty the fuel tank into a suitable fuel storage container. Pump the primer bulb on the carburetor until all fuel is discharged through the clear fuel return hose. Run the engine to remove any fuel that may remain in the carburetor. Perform all regular maintenance procedures and any needed repairs. Remove the spark plug and squirt a very small amount of oil into the cylinder. Pull the starter cord once.

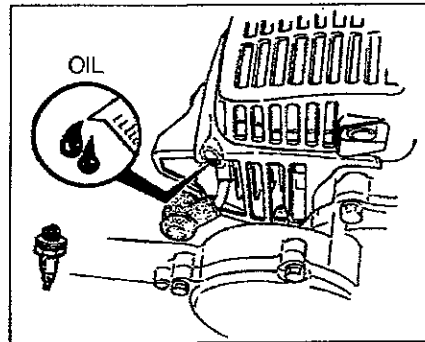

**CAUTION:** Oil may squirt out of the spark plug opening while pulling the starter cord. Protect your eyes and keep your face away from the spark plug opening. Slowly pull the starter cord to bring the piston to the top of the cylinder (TDC). Reinstall the spark plug. Liberally lubricated the blades with a light (#10 wt.) oil. Store the Hedge Trimmer in a dry place away from excessive heat, sparks or open flame.